

21×M6深8

8×Ø6.6完全贯穿
沉孔Ø11深6.4

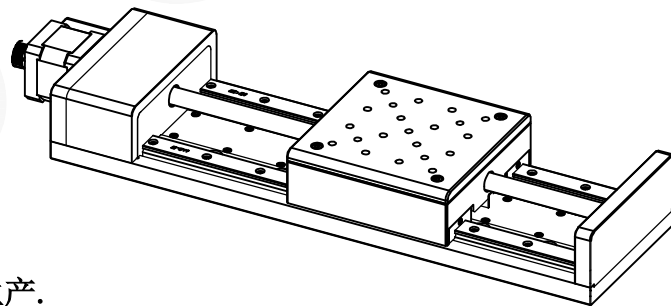

注:

- 1: 本图仅供参考, 禁止使用本图加工生产.
- 2: 细节图纸如有更改不再另行通知.

 GU OPTICS

联合光科技 (北京) 有限公司

名称	直线位移台 台面宽度120mm 行程200mm 步进电机		
产品编号	526676	单位: mm	投影 