

定焦远红外镜头 680219

 8-12 μ m M45

No	项目	规格
1	焦距EFL	50mm
2	探测器Sensor	1280×1024 12 μ m
3	F/#	1
4	视场角FOV (HxV)	17.46°×14.01°
5	工作波长Wavelength	8-12 μ m
6	透过率 Transmittance	>88%
7	膜层 Front Lens Coating	AR膜
8	调焦Focus	光学消热差(整组可调)
9	对焦距离 Focus distance	3m~ ∞
10	后截距	21.7mm
11	后工作距	8mm
12	探测器接口尺寸	M45x1
13	外形尺寸	ϕ 63x61.1mm
14	无热化 Athermalizing	光学无热化 Optical athermalization
15	密封 Sealing	前端IP67
16	温度 Operation Temperature	-40~80°C
17	贮存温度	-50°C~+80°C
18	重量 Weight	225g

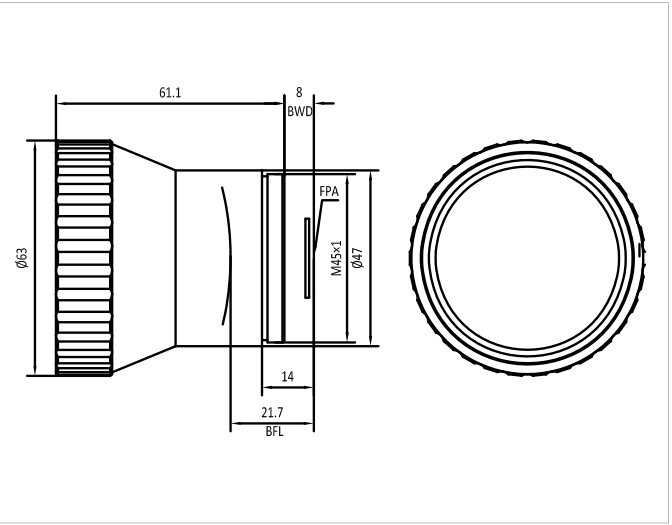